

Arbiton
FLOOR EXPERT



VINYL FLOORING WITH MINERAL CORE



SUPERIORE





TECHNOLOGY

We are a flooring industry company dedicated to utilizing state-of-the-art technology and offering advanced products to our clients. Our emphasis on technological advancements ensures we consistently provide high-quality, modern flooring solutions.



INNOVATION

We are an European leader in the production of floor accessories. We offer advanced and innovative products. We are pushing the flooring industrie forwards for the more effective, ecological and durable solution.



DESIGN

Every year A.DESIGN STUDIO analyzes trends, changes in consumer preferences and hundreds of new floor colors. That's why we can create customer orientated solutions and stay relevant.



Our latest collection of HD Mineral Core flooring boasts the longest planks in the world, measuring a staggering 2.18 meters in length. These extra-long planks make for an incredibly seamless and sophisticated look, perfect for large spaces and modern interiors.

In addition to their impressive length, our SPC panels also feature a synchronized structure that mimics the natural texture and pattern of wood, giving them an authentic and elegant appearance. Each of the 8 colors in our collection includes 10 unique planks.

SUPERIORE

2180 mm

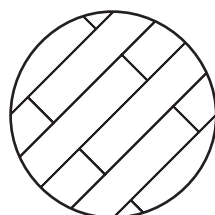

06 TECHNOLOGY

HD MINERAL CORE® TECHNOLOGY

ANTISCRATCH - TITANIUM NANO LAYER

BEAUTIFUL AND PRACTICAL

REAL WOOD STRUCTURE

20 DESIGN

DESIGNED BY A.DESIGN STUDIO

INTERIOR TRENDS

28 INNOVATIONS

WORLD'S FIRST MINERAL DRYBACK COLLECTION

ACULAY - ACOUSTIC FLOORS

34 COLLECTIONS

AMARON SUPERIORE

AMARON WOOD DESIGN

AMARON HERRINGBONE

WOODRIC EIR

WOODRIC

58 COMPREHENSIVE FLOORING SYSTEM

UNDERLAYS

SKIRTING BOARDS

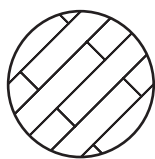

TECHNOLOGY



We are a flooring industry company dedicated to utilizing state-of-the-art technology and offering advanced products to our clients. Our emphasis on technological advancements ensures we consistently provide high-quality, modern flooring solutions.





Modern times become more and more hectic, full of challenges and responsibilities. We live fast, try to make the most of every single moment. We are pushed to look for new solutions, technologies and clever ways to adjust items all around us to meet needs and expectations. With this in mind, **Arbiton HD Mineral Core®** floor was created. This floor impresses and surprises with practicality. Inspired by nature, vinyl floors are entirely designed by European A.Design Studio. Created for people just like you, who get the most out of each moment and enjoy the life to the fullest. The Arbiton floor design not only matches the latest trends, but also go ahead of times and creates them. Thanks to the timeless design its beauty will amaze you every day.

BEAUTIFUL & PRACTICAL

The pace of our life direct us towards solutions that will support and enhance us in everyday situations. That is why **Arbiton HD Mineral Core®** floors have been designed for their maximum comfort of use. Due to their advanced technical properties, they can be installed in any room without expansion joints between rooms. This allows to have beautiful, unified floor throughout the whole level of the apartment. With complete waterproofness and low thermal resistance they are perfect to fit in bathrooms with underfloor heating. They are easy to clean and antistatic, which prevents dust from adhering to them. Moreover, thanks to the innovative Antiscratch - Titanium Nano Layer they are up to 30% more scratch resistant. All of these features and properties mean that you get a floor which will meet the demands of our time. With Arbiton floor you can enjoy life thanks to not only its beauty but also a peace of mind with guaranteed unique functional properties.

BEAUTIFUL



Unique and realistic wood design selected from the most beautiful wood type in the world.



The widest plank available on the market - 229 mm - beautiful and the most natural looking floor.



Soft, delicate and mat finished flooring - the best representation of a real wood.



Nice and silent in everyday use vinyl flooring brings comfort and serenity to everyday life.

PRACTICAL

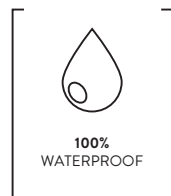

No need to be scared of water. Our floors are 100% waterproof. Frequent cleaning or spilled drinks are no longer dangerous to your floor. Without concerns you can connect your kitchen floor with the rest of your living space.

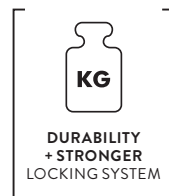

HD Mineral Core® primarily means extremely strong locking system which gives the whole flooring system a maximum durability. Despite of small thickness of the plank our locks are 2 times stronger than average LVT locks available on the market.

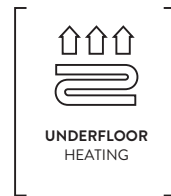

Very low thermal resistance of our floors means more effective use of the underfloor heating system. Thanks to HD Mineral Core® less fuel is needed for floor heating and over 60% less carbon is released into the atmosphere from one household in Europe, each year.

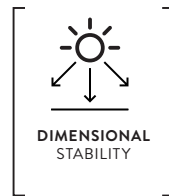

HD Mineral Core® also means high dimensional stability of the floor even in very sunny rooms. We offer at least 2 times higher dimensional stability of our floors in comparison to traditional LVT.

DIMENSIONAL STABILITY
(EN ISO 23999) up to 0,05%

OUR TECHNOLOGIES



Since introducing the mineral core flooring to the market in 2018, we have been continuously developing our technology. Each year, we introduce new innovations, such as the advanced ANTISCRATCH surface, which provides 30% greater protection against scratches.

We also implement innovative synchronous structures with low pattern repetition, creating a unique and visually appealing product.

These changes and innovations are made possible thanks to our in-house research laboratories and dedicated teams of technologists. Our commitment to innovation ensures that we remain at the forefront of the flooring industry.





In our laboratories we've discovered an innovative combination of natural rock minerals and advanced polymers. Carefully combined proportions ensure maximum performance of the floor. Our HD Mineral Core® provides extreme durability. We are proud of the quality of our HD Mineral Core® core free of phthalates and ANY plasticizers.



Our vinyl floor structure impeccably replicates the natural appearance of wood, boasting a significantly higher resolution than standard products. Additionally, the design offers remarkable uniqueness, with up to 10 distinctive planks in each color variant, ensuring a truly authentic aesthetic.



In 2020, the ANTISCRATCH technology was introduced, effectively eliminating the most common issue with vinyl flooring - micro-scratches - and providing enhanced durability for the flooring surface.



A suitable underlayment for click vinyl is essential, as it not only provides acoustic insulation but also contributes to the durability of the flooring, making it crucial to select an underlayment tailored to your specific needs.



**DESIGN
BEVEL**

Our vinyl floor structure impeccably replicates the natural appearance of wood, boasting a significantly higher resolution than standard products. Additionally, the design offers remarkable uniqueness, with up to 10 distinctive planks in each color variant, ensuring a truly authentic aesthetic.

HD MINERAL CORE®

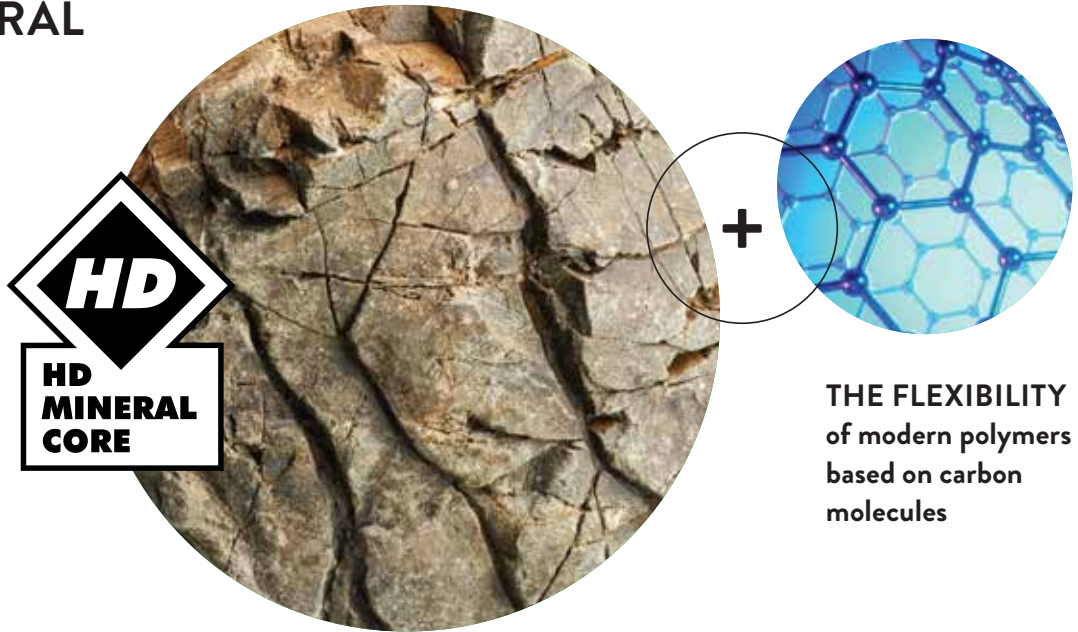

HARDNESS
and durability of natural
rock minerals

In our laboratories we've discovered an innovative combination of natural rock minerals and advanced polymers. Carefully combined proportions ensure maximum performance of the floor. Our HD Mineral Core® provides extreme durability which we confirm by giving you 20 year guarantee. We are proud of the quality of our products free of phthalates and harmful plasticizers.

ANTISCRATCH - TITANIUM NANO LAYER UV COATING LAYER WEAR LAYER DESIGN LAYER HD MINERAL CORE®

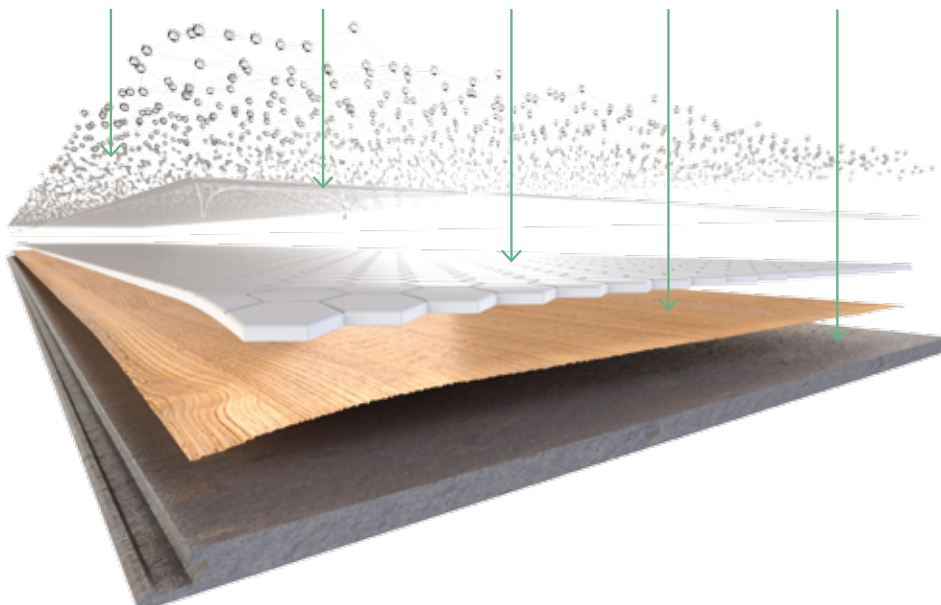

BENEFITS OF HD MINERAL CORE

THE PERFECT FLOOR FOR UNDERFLOOR HEATING



The perfect floor for underfloor heating - maximize your energy efficiency with Arbiton flooring! Efficient heating starts with the right flooring - choose our high-conductive option for underfloor heating

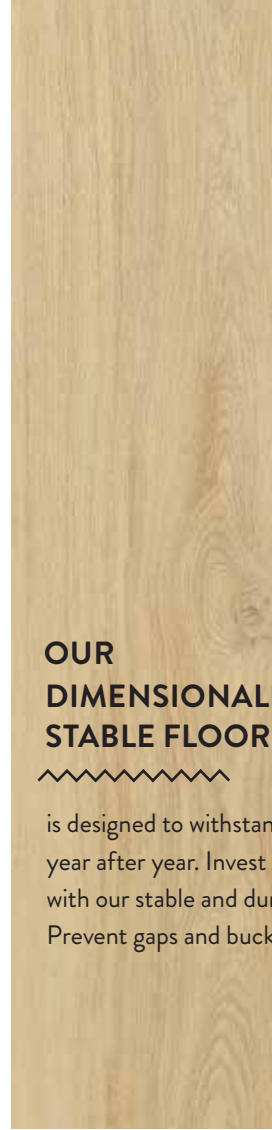
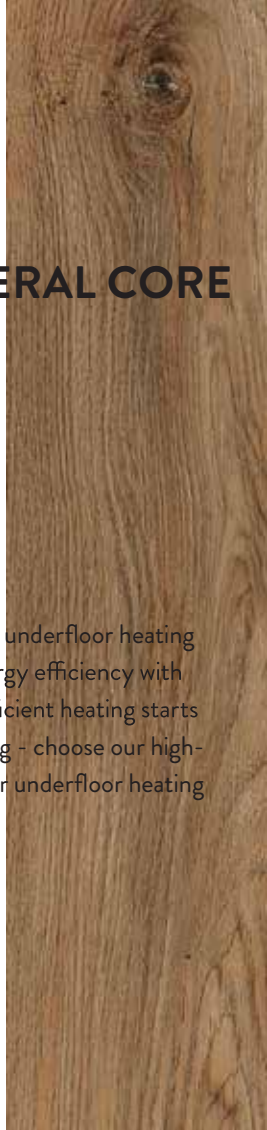

OUR DIMENSIONALLY STABLE FLOORING



is designed to withstand daily wear and tear, year after year. Invest in long-lasting quality with our stable and durable flooring option. Prevent gaps and buckling for a seamless look.

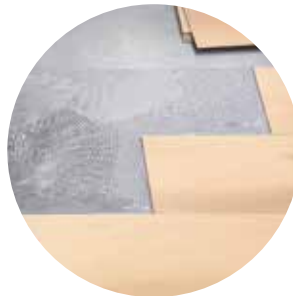
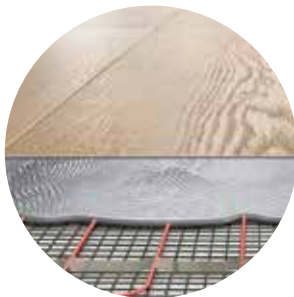

THE SAME HIGH-QUALITY TECHNOLOGY IN OUR GLUE-DOWN AND CLICK FLOORING OPTIONS



Choose the installation method that suits your needs - our technology is available in both click or glue!

ANTISCRATCH LAYER

**30%
MORE**
RESISTANT SURFACE*

**ANTI-
SCRATCH**
**TITANIUM
NANO-LAYER**

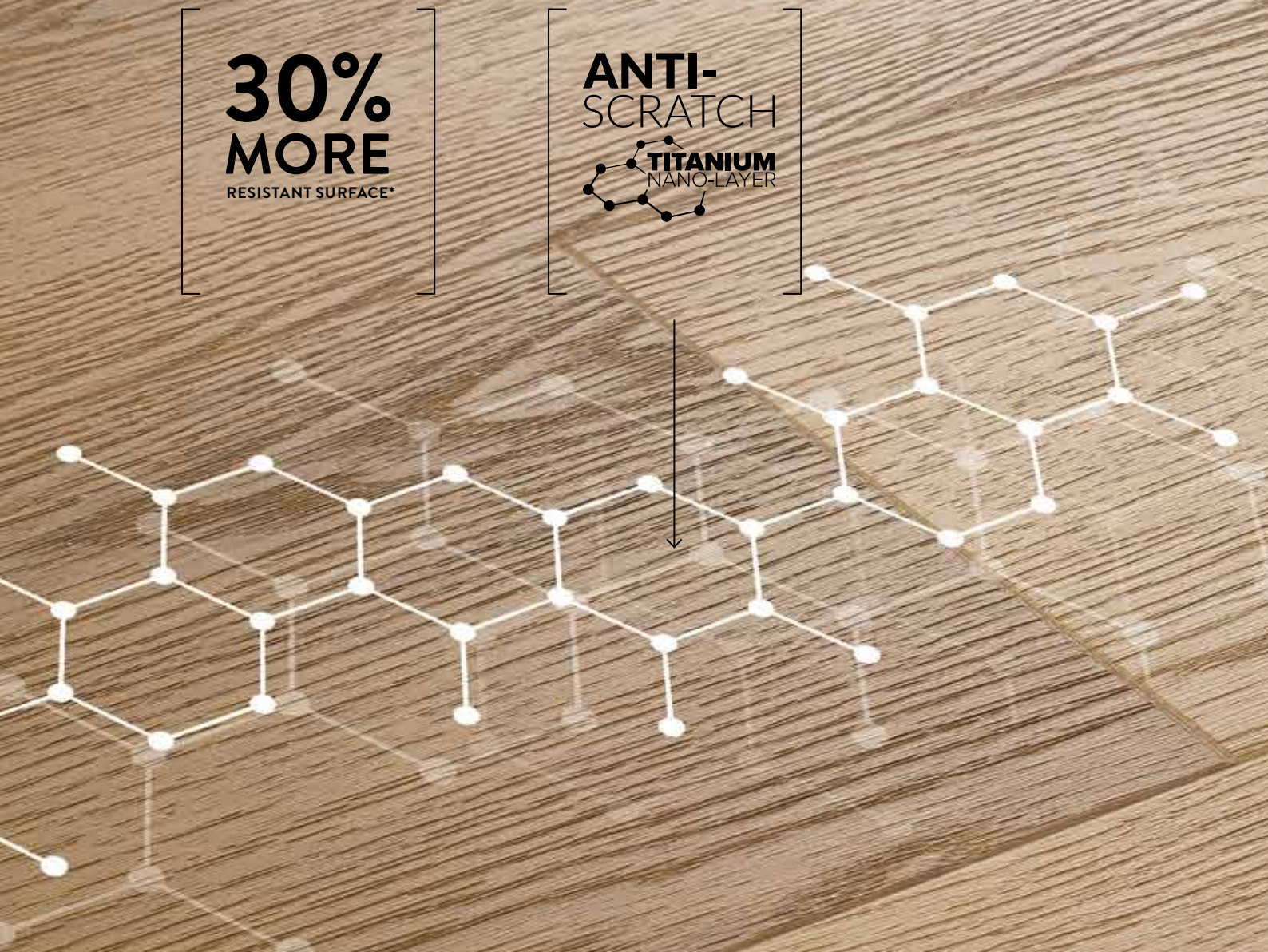



**FLOOR WITH
ANTISCRATCH -
TITANIUM NANO LAYER**



**STANDARD
LVT**

For last couple of years, professional automotive workshops offer protection of a paint layer. For additional fee, we can protect the paint coating with specially selected cosmetics. This service is mostly done on the new car even before it has left the dealership. The factory lacquer coating is being covered with ceramic or nanoparticles coating.

This service satisfy the most demanding customers who want to enjoy the beautiful appearance of the car for years. Antiscratch - Titanium Nano Layer is inspired by these premium automotive detailing process. Antiscratch - Titanium Nano Layer protects the panels and secure them against micro scratches that can occur in the regular lifespan of use.

The Antiscratch - Titanium Nano Layer protective coating is available in the top Arbiton collections - Amaron and Woodric. Technology used in these collections outperform in durability and scratch-resistance tests the majority of vinyl panels on the market. As a result sand, or even mud are no longer a threat because of the Antiscratch - Titanium Nano Layer and waterproofness protection. This means that Arbiton Amaron and Woodric can be easily installed in kitchens, dining rooms or even in bathrooms. And all these rooms can be unified – up to 200 m² without additional expansion joints. The combination of HD Mineral Core[®] and Antiscratch - Titanium Nano Layer guarantees a beautiful floor for many years.

REAL WOOD STRUCTURE



High variety of designs means more natural impression of flooring. Perfect resemblance of wooden boards is a key benefit of our new collections. Minimum of 10 different planks in each colour means naturally flowing design without repetition of grains and knots.

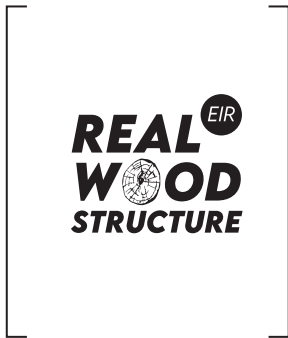

**DEEP MATT
SURFACE**

**NATURAL FLOW
OF DESIGNED
STRUCTURE**

**HIGH RESOLUTION
EMBOSSING**

For those who strive for the best looking floor and high durability we have prepared an absolute novelty. Our new collections is made using embossing technology perfectly resembling wooden structure on a planks.

The EIR (embossed in register) technology we are using allow us to achieve higher resolution of embossing, meaning higher density of details enriching surface of planks. Our design has more knots, grain, clear figure, small indentation that create real wooden characteristic of the plank. A beautiful matte surface will gently emphasize the beautiful finish of the floor.

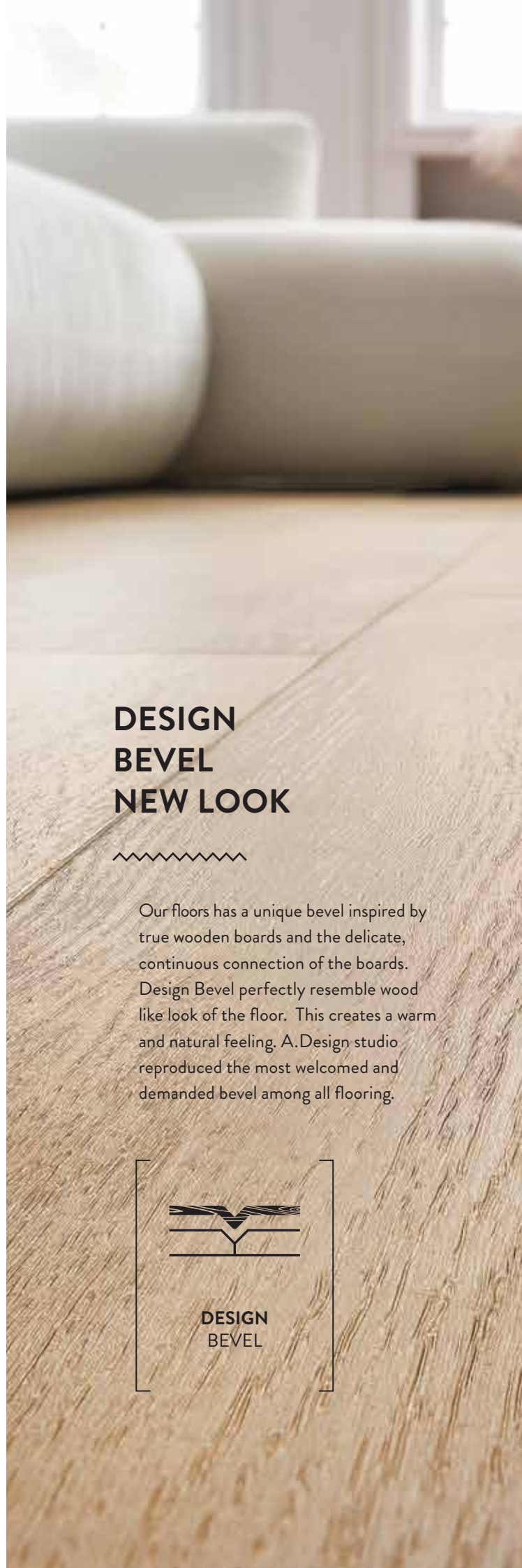

DESIGN BEVEL NEW LOOK



Our floors has a unique bevel inspired by true wooden boards and the delicate, continuous connection of the boards. Design Bevel perfectly resemble wood like look of the floor. This creates a warm and natural feeling. A.Design studio reproduced the most welcomed and demanded bevel among all flooring.



**DESIGN
BEVEL**





We make use of the reputable Välinge company's license to ensure the highest quality for our flooring products. By incorporating their innovative locking system into our floors, we guarantee durability and ease of installation.



WOODRIC COLLECTION (4 mm)
4,5 kN/m (long) / 5,5 kN/m (short)



AMARON SUPERIORE COLLECTION (5 mm)
AMARON WOOD COLLECTION (5 mm)
5,2 kN/m (long) / 6,5 kN/m (short)



AMARON HERRINBONE COLLECTION (5 mm)
5,2 kN/m (long) / 6,5 kN/m (short)





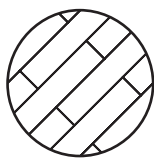

DESIGN



Every year A.DESIGN STUDIO analyzes trends, changes in consumer preferences and hundreds of new floor colors. That's why we can create customer orientated solutions and stay relevant.





A DESIGN STUDIO.



OAK-INSPIRED FLOORING MASTERY

Our oak wood-inspired flooring is perfect for those who appreciate the elegance and charm of natural wood, but also want a practical and modern flooring solution. Our flooring products can be installed in a wide range of settings, from residential homes to commercial spaces.

Our design studio specializes in creating stunning decor that reflects the look and feel of oak wood. We scour the world to find the finest quality oak wood and carefully study its unique patterns, grains, and colors.

Using advanced techniques and innovative technology, we replicate these natural elements in our flooring products. The result is a flooring solution that not only captures the beauty of oak wood, but also offers superior durability and longevity.





At our design studio, we take pride in our commitment to quality and our passion for creating unique and beautiful designs. We're confident that our oak wood-inspired flooring will exceed your expectations and add warmth and character to your space.

TRENDS



In this chapter of our catalog, we explore the various interior design styles and how the shades and character of flooring can shape the overall look and feel of a space. The choice of flooring can significantly influence the ambiance, whether it's the clean lines of mid-century modern, the industrial charm of a loft, the cozy warmth of hygge, the free-spirited nature of boho, or the minimalist elegance of Japanese and wabi-sabi designs. Each style has its unique aesthetic, and selecting the right flooring can make all the difference in achieving your desired interior design. Let us guide you through these distinctive styles and help you find the perfect flooring solution to elevate your space.

Mid century

Mid-century modern is a design style that originated in the mid-20th century, characterized by its clean lines, organic shapes, and emphasis on functionality. This style pays homage to the iconic furniture designs and architectural trends of the 1950s and 1960s, often incorporating elements such as tapered legs, geometric patterns, and a mix of natural and synthetic materials. The color palette for mid-century interiors typically includes a combination of neutral tones, vibrant colors, and earthy hues, reflecting the optimism and innovation of the era. In mid-century spaces, minimal ornamentation and an open layout create a sense of flow and harmony, allowing the iconic furniture pieces and accessories to take center stage. When it comes to flooring, oak floors with a warm, medium-toned finish and a subtle grain pattern are a perfect match for the mid-century style, providing a timeless and elegant backdrop that complements the distinctive design elements and adds a touch of warmth to the overall aesthetic.

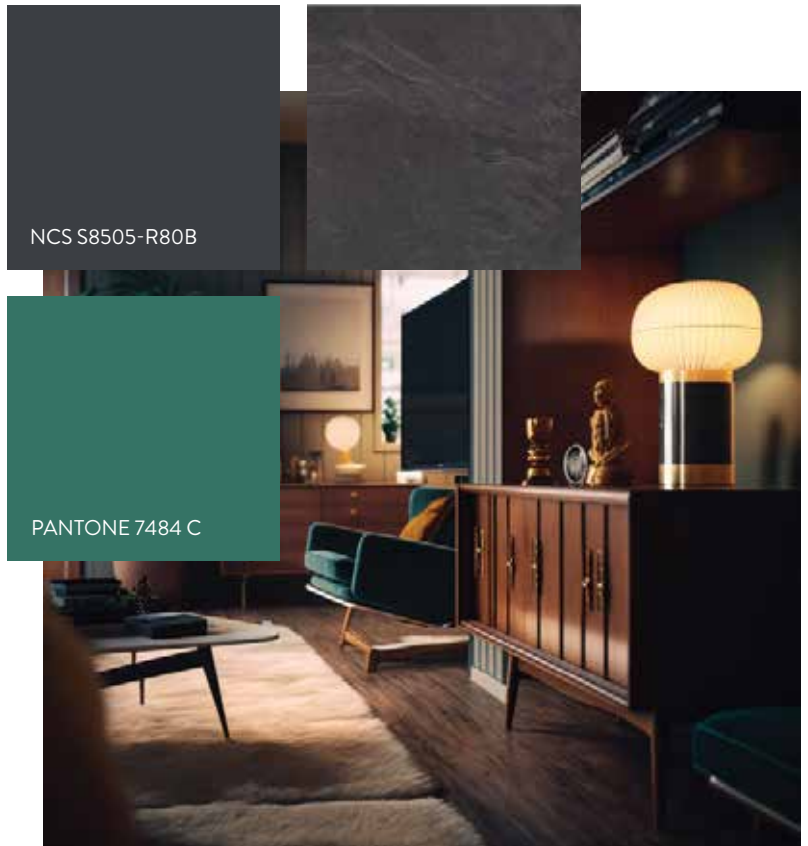

NCS S8505-R80B

PANTONE 7484 C



SEGOVIAOAK
AMARON WOOD
SU CASS 225



Hygge

Hygge, a Danish concept that embodies a sense of coziness, warmth, and well-being, has gained significant popularity in the world of interior design.

Hygge-inspired spaces prioritize comfort and create an atmosphere of tranquility, often featuring soft lighting, plush textiles, and an emphasis on natural materials.

The color palette for this design style is typically neutral, with subtle hints of earthy tones and pastels that evoke a sense of calm and relaxation. Hygge interiors are designed to encourage connection, mindfulness, and the enjoyment of life's simple pleasures. In terms of flooring, oak floors with a light, soothing color palette and a natural, matte finish are an ideal choice for a hygge-inspired space, seamlessly blending with the gentle ambiance and promoting an overall sense of warmth and contentment.



NCS S7020-R70B



RAL5013



CORNEL OAK
AMARON WOOD
CAS224



Boho

Boho, short for bohemian, is an eclectic and free-spirited interior design style that embraces a mix of colors, patterns, textures, and cultural influences. Boho interiors are characterized by a relaxed and inviting atmosphere, often featuring an abundance of greenery, vintage furniture, and a variety of decorative accents. Layering different textiles, such as rugs, throws, and cushions, is a key element of this design style, as well as incorporating a diverse range of art, antiques, and travel souvenirs. Boho spaces celebrate creativity, individuality, and the art of self-expression. When it comes to flooring, oak floors with warm, rich tones and a slightly distressed or aged finish provide the ideal foundation for a boho-inspired space, adding an authentic, lived-in charm that enhances the overall aesthetic.



PANTONE 480C



RAL 1032

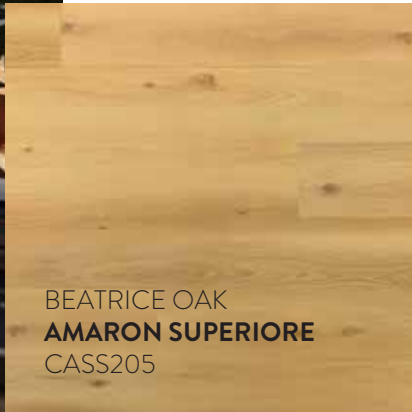

BEATRICE OAK
AMARON SUPERIORE
CASS205

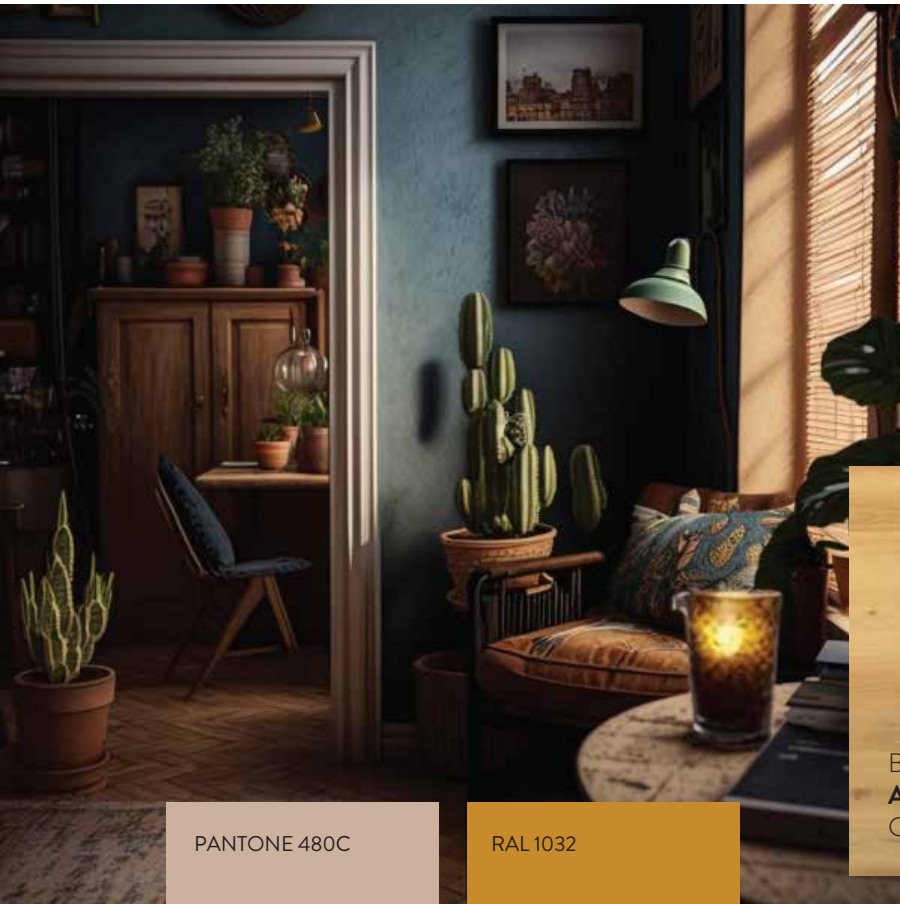

Japandi

Japandi, a unique fusion of Japanese and Scandinavian design principles, has emerged as a popular interior design trend that brings together the best of both worlds. By combining the simplicity and minimalism of Scandinavian design with the elegance and sophistication of Japanese aesthetics, Japandi creates a harmonious balance between form and function. This design style emphasizes clean lines, natural materials, and a neutral color palette, creating a sense of serenity and tranquility within the space. Japandi interiors often feature a mix of wood, stone, and natural textures, as well as an emphasis on craftsmanship and attention to detail. When it comes to flooring, oak floors with a subtle, muted color palette and a natural, matte finish perfectly complement the Japandi style, echoing the warmth and timeless character of this design philosophy.

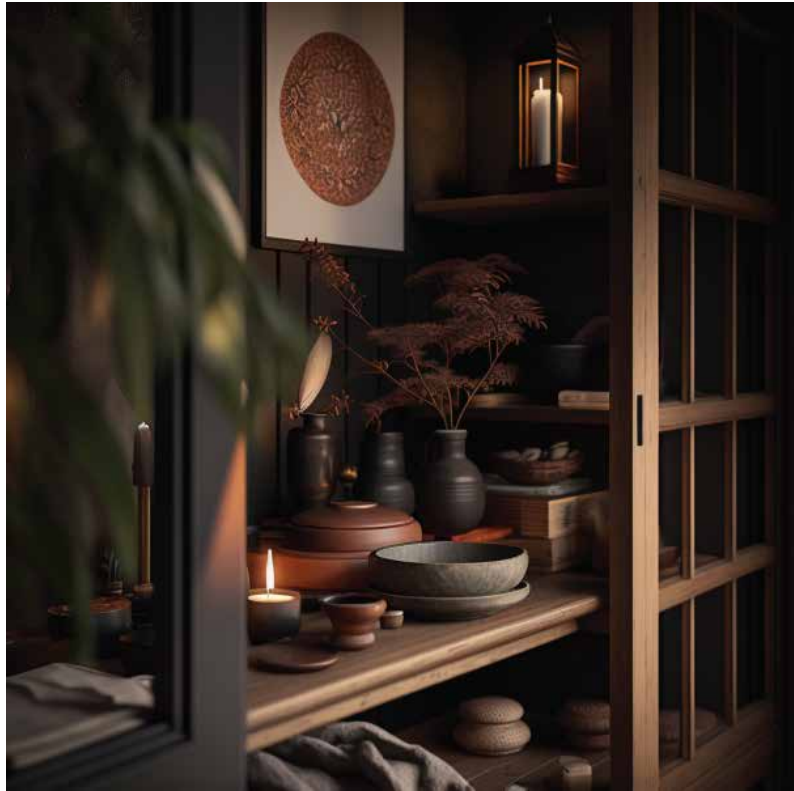

MATTARI OAK
AMARON WOOD
CAS221

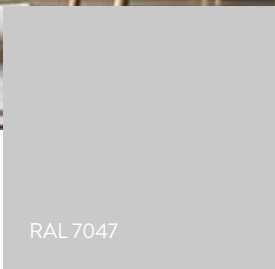
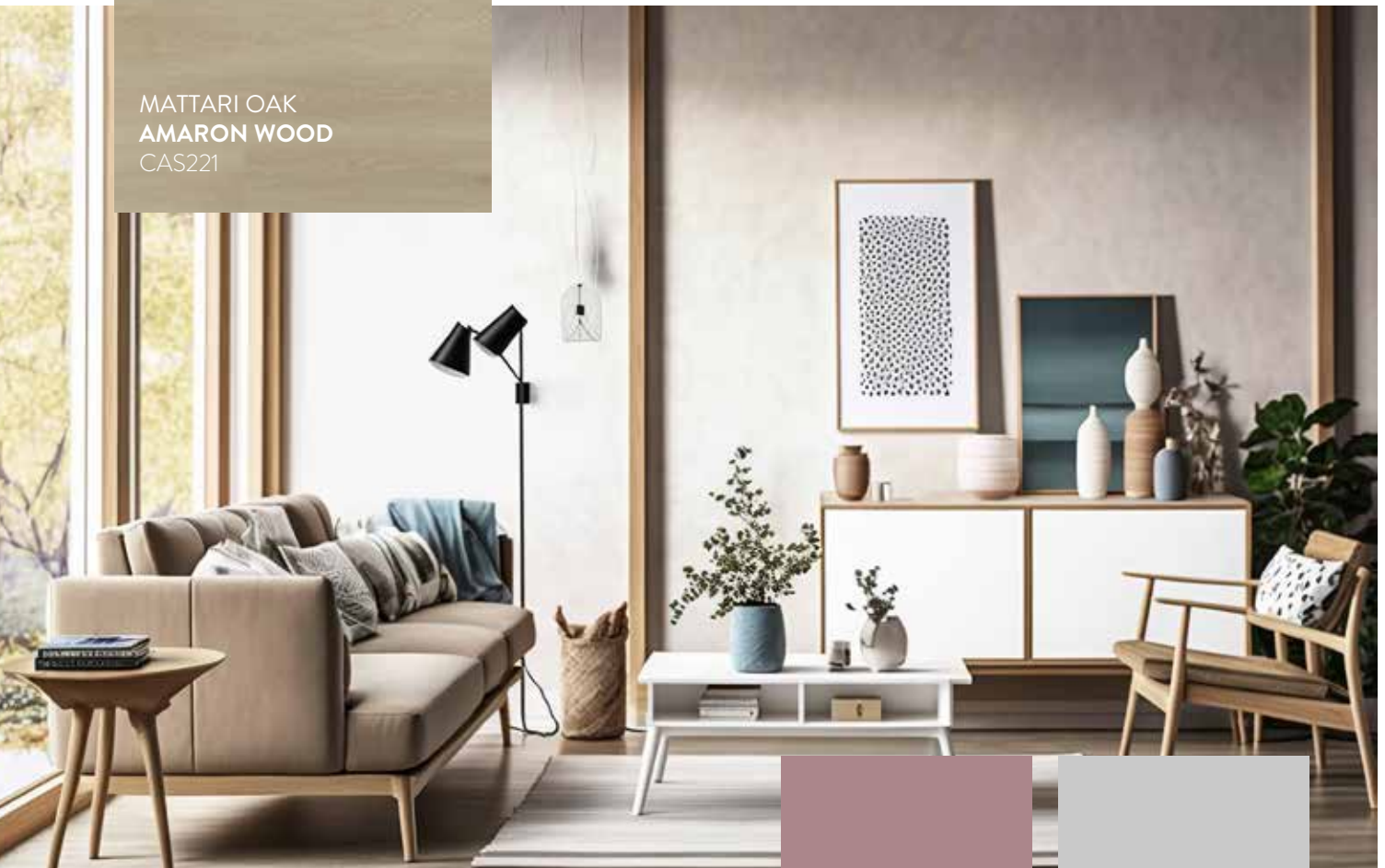

Wabi Sabi

Wabi-sabi, a Japanese aesthetic philosophy, is centered around embracing the beauty of imperfection, impermanence, and simplicity. In interior design, wabi-sabi spaces celebrate the raw, organic, and unrefined aspects of life, often featuring natural materials, handcrafted elements, and a minimalist approach to decor. The color palette is dominated by subdued, earthy tones that evoke a sense of serenity and harmony with the natural world. Wabi-sabi interiors encourage mindfulness and appreciation for the imperfect charm of objects and spaces, fostering a deeper connection to the environment. When it comes to flooring, oak floors with a subtle, weathered appearance and a matte, organic finish are a perfect complement to the wabi-sabi style, echoing the philosophy's emphasis on embracing the inherent beauty of natural imperfections and the passage of time.



NCS S2005-Y60R

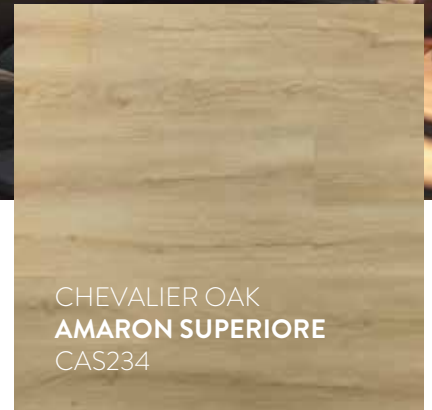

CHEVALIER OAK
AMARON SUPERIORE
CAS234



EMPIRE OAK
AMARON WOOD
CAS226

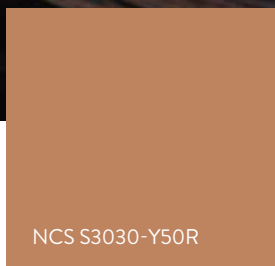
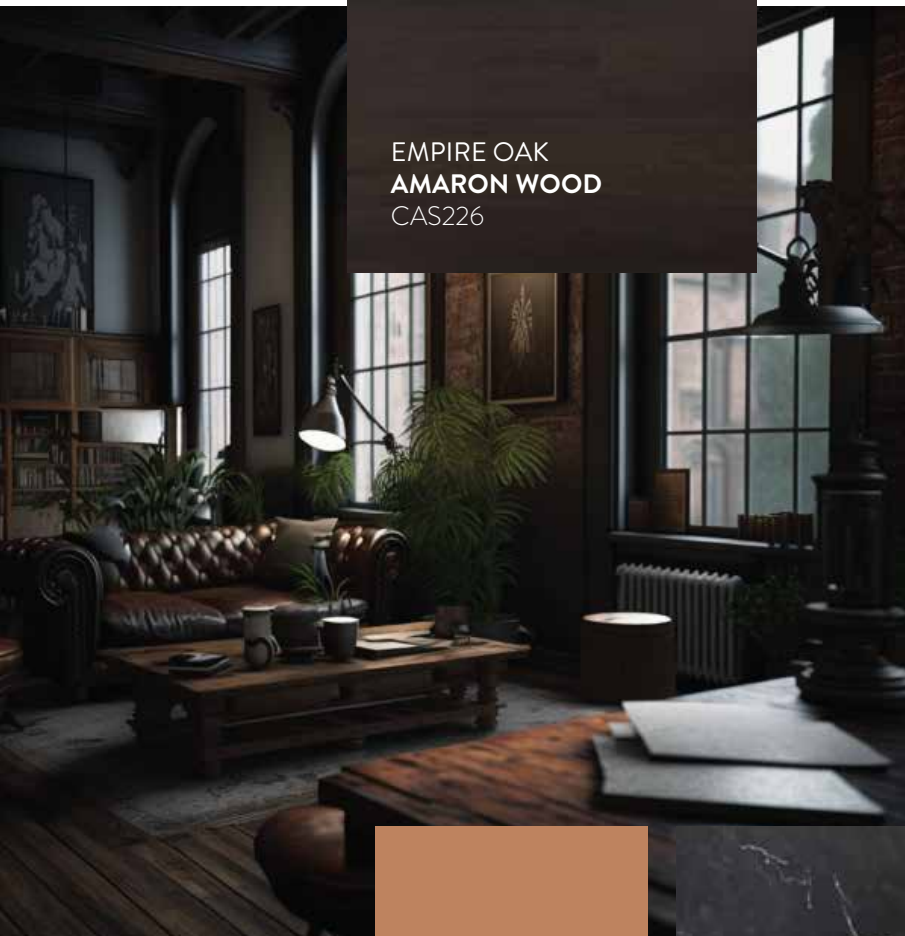

NCS S3030-Y50R

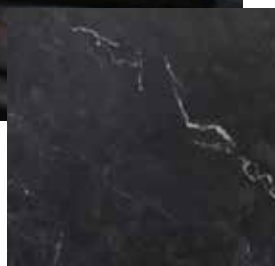

Loft

The loft style, inspired by the industrial and urban environments of converted warehouse spaces, is characterized by its open-concept layout, high ceilings, and exposed architectural elements such as brick walls and metal beams. In interior design, loft spaces typically feature a blend of raw, rugged materials and sleek, contemporary furnishings, creating a unique atmosphere that is both stylish and functional. The color palette for this design style is often neutral, with bold accents and a mix of textures to add visual interest and depth. Loft interiors emphasize the use of repurposed, vintage, and industrial elements, resulting in a space that feels both modern and full of character. When it comes to flooring, oak floors with a dark, rich color palette and a slightly distressed or reclaimed finish are an excellent choice for a loft-inspired space, enhancing the industrial aesthetic and providing a strong, durable foundation for the overall design.

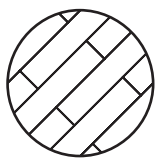

INNOVATIONS





WORLD'S FIRST MINERAL DRYBACK COLLECTION:



EXPERIENCE THE VERSATILITY OF DRYBACK

Arbiton breaks new ground with the innovative Mineral Dryback technology.

Featuring the cutting-edge HD Mineral Core, is a first mineral dryback in the industry, delivering exceptional dimensional stability that prevents gaps between panels.

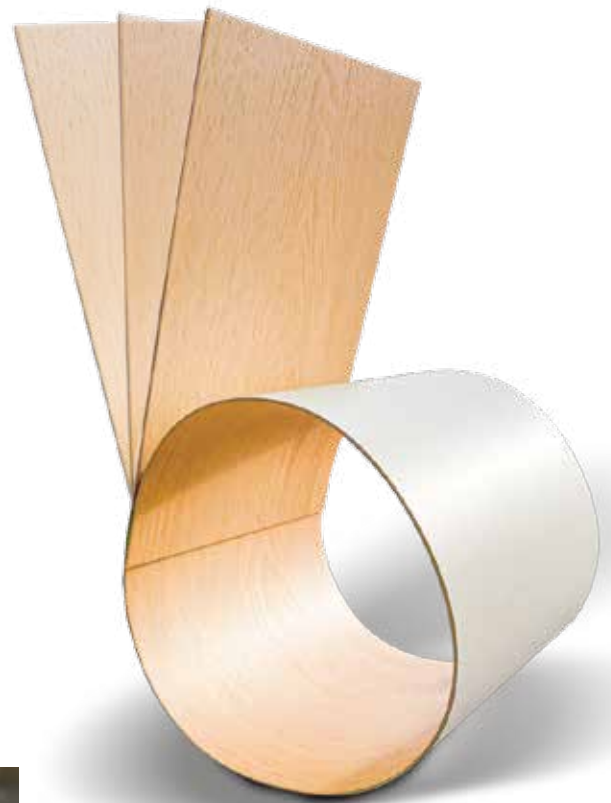

ONE FLOOR,
MANY APPLICATIONS



Restaurant

Hotel



IT'S DIMENSIONALLY STABLE

With its legendary dimensional stability of 0,05%, you can get rid of the annoying and unsightly gaps that appear at the panel joints after several seasons, especially in variable climatic conditions.

IT'S PERFECT FOR FLOOR HEATING

$R=0,01 \text{ m}^2\text{K/W}$! Next to ceramic tiles, it is probably the most effective floor covering for underfloor heating in the world!

IT'S FLEXIBLE

You can work with it like with any other lvt dryback, you can use the same tools and work in the same way.



IT'S TESTED & APPROVED

Tested and recommended by all major adhesive manufacturers like UZIN, MAPEI, BOSTIK, KIESEL, ARDEX, BAUTEC, WAKOL

IT'S EVEN MORE DURABLE

The Mineral Dryback floor made in HD Mineral Core technology is even more durable. Usability Class 33/42, Antiscratch Titanium Nano Layer and parameter of $RI=0,02$ makes it a perfect choice for commercial use.

IT'S SUPER SILENT

Yes, it is! if you need a really quiet floor, a glued mineral dryback is the best choice.

ACULAY - ACOUSTIC FLOORS



We are proud to introduce our new vinyl floors with a mineral core, featuring an integrated acoustic underlay called ACULAY. This innovative combination of panel and underlay provides a faster and easier installation process. As a European leader in underlay production, we guarantee that the ACULAY underlay is highly durable and meets all MMFA standards. Additionally, it offers an impressive sound reduction of 19 dB, and with a strength of 400 kPa, it is perfectly suited for use in all residential spaces.



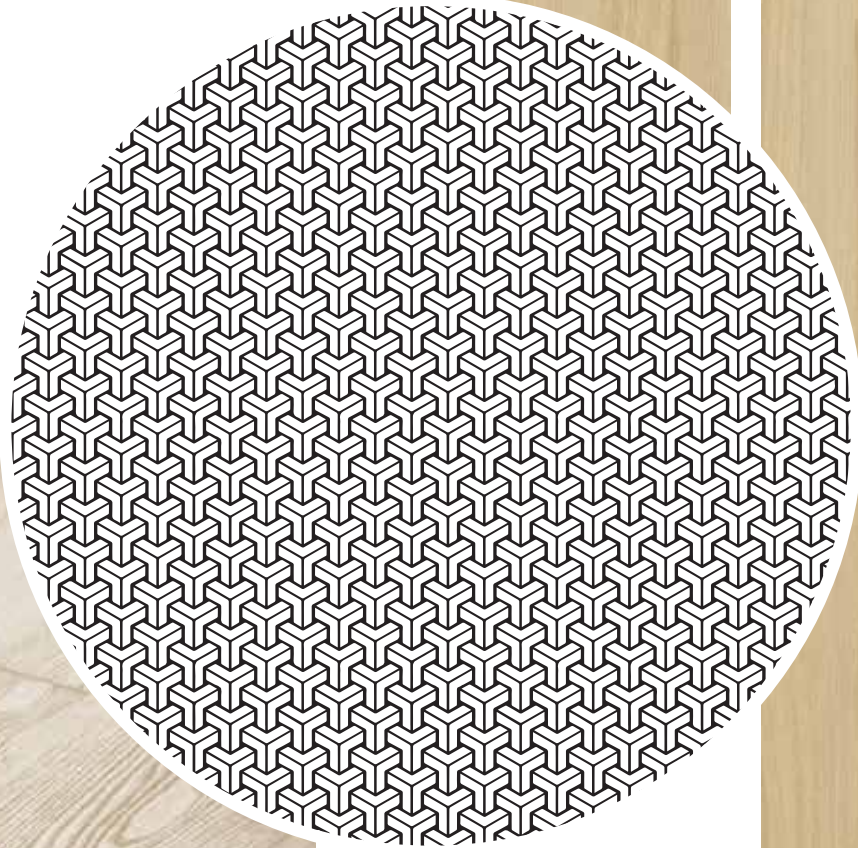

**ACOUSTIC
INSULATION**

19 db

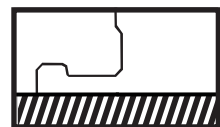

**INTEGRATED
ACOUSTIC
LAYER**

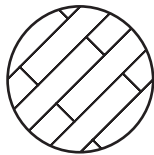

COLLECTIONS



Our latest collection of HD Mineral Core flooring boasts the longest planks in the world, measuring a staggering 2.18 meters in length. These extra-long planks make for an incredibly seamless and sophisticated look, perfect for large spaces and modern interiors.







AMARON SUPERIORE
229 mm x 2180 mm

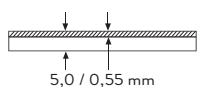

AMARON WOOD
229 mm x 1511 mm

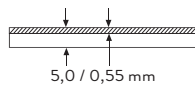

AMARON HERRINGBONE
148 mm x 592 mm

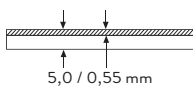

WOODRIC
229 mm x 1220 mm

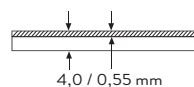

DRYBACK FLOORING



**AMARON
HERRINGBONE**
154 mm x 616 mm

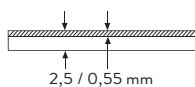

**AMARON
WOOD**
236 mm x 1518 mm

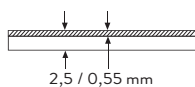

**WOODRIC
DRYBACK**
236 mm x 1227 mm

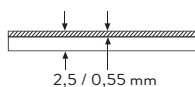

AMARON SUPER!ORE

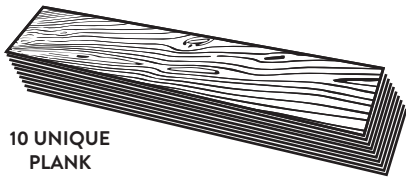

10 UNIQUE
PLANK
DESIGNS



25 YEARS
WARRANTY
RESIDENTIAL



THERMAL
RESISTANCE
0,014 m²K/W

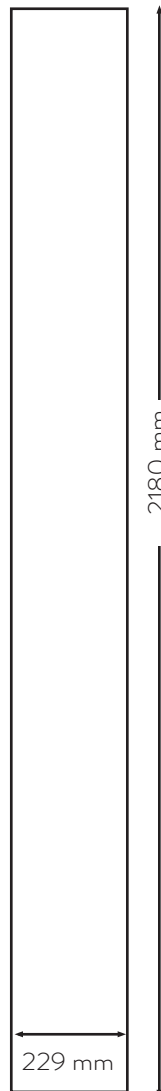
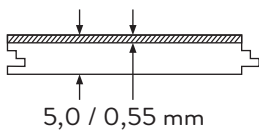



SEGOVIA OAK
CASS 225

AMARON SUPER!ORE



A collection created for the most demanding. The largest panel available, 2180 mm long and 229 mm wide. Additionally, NATURAL SYNCHRONO STRUCTURE, faithfully resembles natural wood. In four delightful designs, beautiful natural shades of oak. The perfect floor, created for perfect interiors.



BURBON OAK
SU CASS 208



BEATRICE OAK

SU CASS 205

EAN: 5905167856505



ASTURIA OAK

SU CASS 210

EAN: 5905167856536



CHEVALIER OAK

SU CASS 234

EAN: 5905167856567



CHARLOTTE OAK

SU CASS 233

EAN: 5905167856550



BURBON OAK

SU CASS 208

EAN: 5905167856529



GREYLAND OAK

SU CASS 202

EAN: 5905167856543



SEGOVIA OAK

SU CASS 225

EAN: 5905167856512



BALMORAL OAK

SU CASS 235

EAN: 5905167856574



BALMORAL OAK
SU CASS 235

AMARON WOOD



10 DESIGNS

4 DESIGNS



CLICK
FLOORING



DRYBACK
FLOORING



25
YEARS

WARRANTY
RESIDENTIAL



THERMAL
RESISTANCE:
DRYBACK - 0,01 m²K/W
CLICK - 0,014 m²K/W

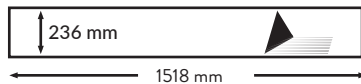
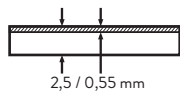
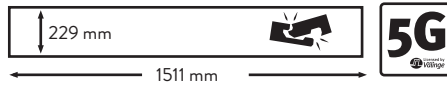
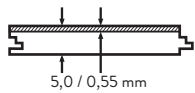



ROCHESTER OAK
CAS 229

AMARON WOOD



Amaron WOOD means expressive designs which will create the character of the interior. The floors in this collection have the highest usage class, created for the most demanding customers. This floor will play first fiddle. The 5G lock makes the floor easy and fast to install. A beautiful floor is a crucial element of interior design. It brings character to the unified design or lets you play a bit with contrast in modern or typically loft interiors. In any way, the floor is the element that helps to create an interesting space- where colours, textures and shapes result in the imagined effect-a sense of harmony and undisputed beauty. Having that in mind, we have created Amaron Wood vinyl click floor.



ALASKAN OAK

CAS 102

Click: 5905167856369

Dryback: 5905167857694



YANKEE OAK

CAS 153

Click: 5905167856376

Dryback: 5905167857700



SIERRA OAK

CAS 154

Click: 5905167856383

Dryback: 5905167857717



GEORGETOWN OAK

CAS 147

Click: 5905167856390

Dryback: 5905167857724



TAMPA OAK

CAS 220

Click: 5905167856406

Dryback: 5905167857731

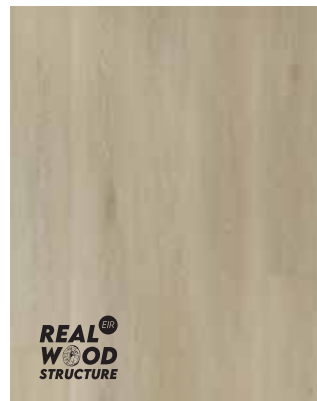

MATTARI OAK

CAS 221

Click: 5905167856413

Dryback: 5905167857748

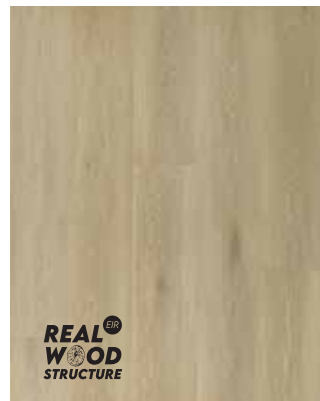

JOHANNES OAK

CAS 222

Click: 5905167856420

Dryback: 5905167857755



MENOR OAK

CAS 223

Click: 5905167856437

Dryback: 5905167857762



CORNEL OAK

CAS 224



Click: 5905167856444

Dryback: 5905167857779

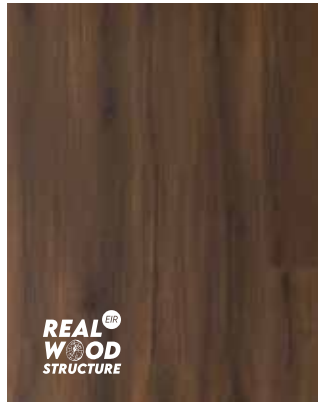

MONTANA OAK

CAS225



Click: 5905167856451

Dryback: 5905167857786



EMPIRE OAK

CAS 226



Click: 5905167856468

Dryback: 5905167857793

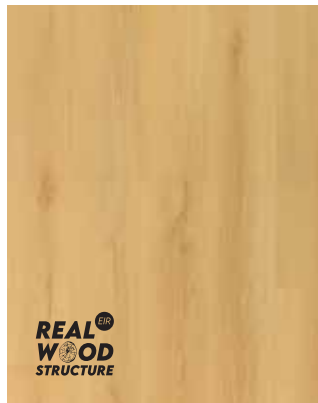

VIRGIN OAK

CAS 227



Click: 5905167856475

Dryback: 5905167857809



PRINCETON OAK

CAS 228



Click: 5905167856482

Dryback: 5905167857816



ROCHESTER OAK

CAS 229



Click: 5905167856499

Dryback: 5905167857823



PRINCETON OAK
CAS 228

AMARON HERRINGBONE



4 DESIGNS

10 DESIGNS



CLICK
FLOORING



DRYBACK
FLOORING



25
YEARS

WARRANTY
RESIDENTIAL



THERMAL
RESISTANCE:
DRYBACK - 0,01 m²K/W
CLICK - 0,014 m²K/W

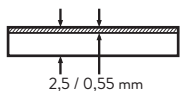
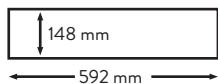
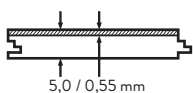

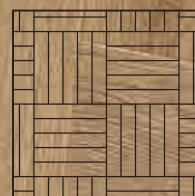

**4 PATTERNS
OF FLOOR
LAYING**

AMARON HERRINGBONE



Fashion passes- just to return later. Trends come and go but precious few hold on for a long time. Our Amaron Herringbone vinyl click floor is designed to belong to the latter group. Thanks to specially designed locking system this collection might be arranged in the iconic English herringbone pattern. This is an amazing way to adjunct traditional interior arrangements. The main element that indicates the direction of the interior style is the floor – any further decisions regarding the interior are based upon it. Furniture, textures, fabrics, accessories – all of those either correspond to the selected floor or stay in opposition on the basis of divergence. Regardless of which approach you choose, you can stay calm knowing that the Arbiton panels will secure you the highest quality.



PRESTON OAK

CA 167



Click: 5905167839362

Dryback: 5905167857595



HARLOW OAK

CA 158



Click: 5905167826676

Dryback: 5905167857557



WEMBLEY OAK

CA 159



Click: 5905167826683

Dryback: 5905167857564



YANKEE OAK

CA 153



Click: 5905167839348

Dryback: 5905167857571



DEARWOOD OAK

CA 187



Click: 5905167839522

Dryback: 5905167857632



STAMFORD OAK

CA 181



Click: 5905167839515

Dryback: 5905167857625



WINDSOR OAK

CA 184



Click: 5905167839539

Dryback: 5905167857649



GEORGETOWN OAK

CA 147



Click: 5905167839355

Dryback: 5905167857588



HAYWORTH OAK

CAS 176

Click: 5905167839492

Dryback: 5905167857601



MEDICCI OAK

CAS 177

Click: 5905167839508

Dryback: 5905167857618



**BURBON OAK
CAS 208**



**GEORGETOWN OAK
CA 147**

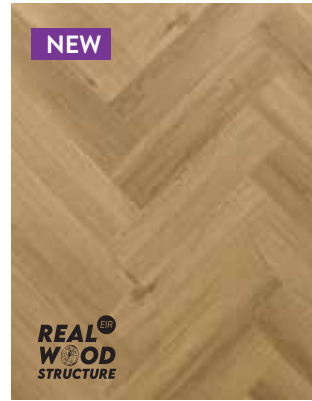

BURBON OAK

CAS 208

Click: 5905167857113

Dryback: 5905167857670

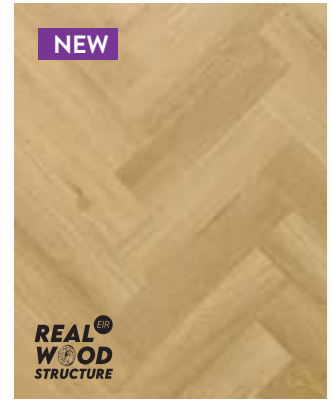

MENOR OAK

CAS 223

Click: 5905167857090

Dryback: 5905167857656

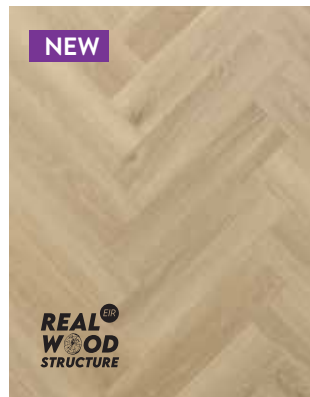

DEVENTER OAK

CAS 236

Click: 5905167857120

Dryback: 905167857687

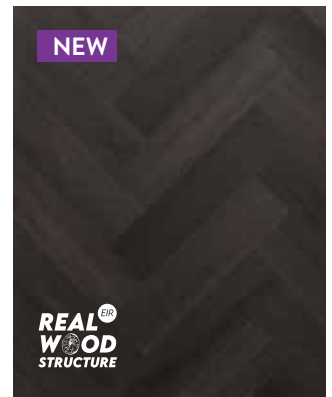

EMPIRE OAK

CAS 226

Click: 5905167857106

Dryback: 5905167857663

ARBITON WOODRIC EIR



12 DESIGNS

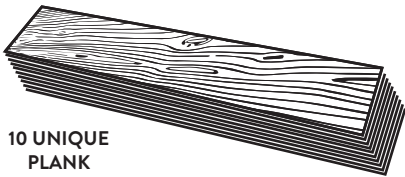

10 UNIQUE
PLANK
DESIGNS



20 YEARS
WARRANTY
RESIDENTIAL



THERMAL
RESISTANCE:
DRYBACK - 0,01 m²K/W
CLICK - 0,012 m²K/W

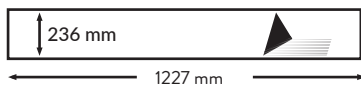
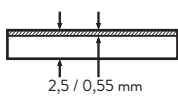
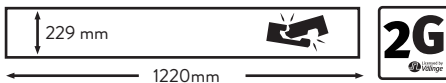
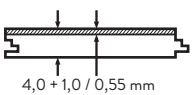
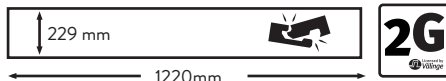
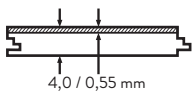



**CLICK
FLOORING**



**DRYBACK
FLOORING**



**INTEGRATED
ACOUSTIC
LAYER**

**3 SYSTEMS
OF FLOOR
INSTALLATION**

WOODRIC EIR



Woodric EIR has beautiful 12 designs that are enriched with deep embossing to resemble natural wood board in the most honest way. Embossed in register technology allow to create indentation on the board that will create the unique pattern of wood. All of this premium visual and haptic features comes with well-known durability of HD Mineral Core® technology.



DAYTON OAK

CWS 201

Click: 5905167847671

Dryback: 5905167855591

Acoustic: 5905167858271



BALTIMORE OAK

CWS 202

Click: 5905167847688

Dryback: 5905167855607

Acoustic: 5905167858288



BRANDON OAK

CWS 203

Click: 5905167847695

Dryback: 5905167855614

Acoustic: 5905167858295



ELDBORG OAK

CWS 204

Click: 5905167847701

Dryback: 5905167855621

Acoustic: 5905167858301

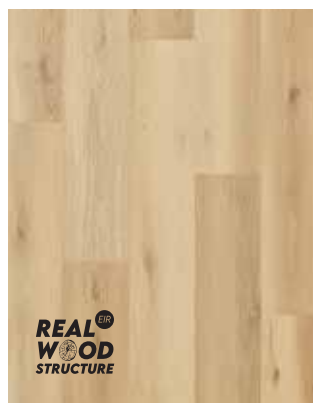

HIGHLANDS OAK

CWS 205

Click: 5905167847718

Dryback: 5905167855638

Acoustic: 5905167858318



LAVANT OAK

CWS 206

Click: 5905167847725

Dryback: 5905167855645

Acoustic: 5905167858325



NORDLAND OAK

CWS 207

Click: 5905167847732

Dryback: 5905167855652

Acoustic: 5905167858332



GARLAND OAK

CWS 208

Click: 5905167847749

Dryback: 5905167855669

Acoustic: 5905167858349



SALERNO OAK

CWS 209

Click: 5905167847756

Dryback: 5905167855676

Acoustic: 5905167858356

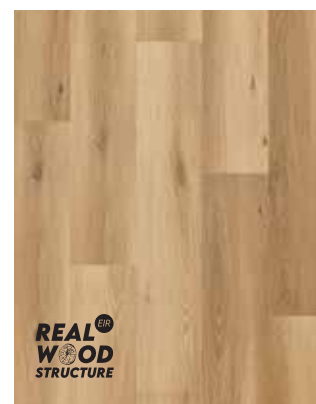

CAVILLON OAK

CWS 210

Click: 5905167847763

Dryback: 5905167855683

Acoustic: 5905167858363



DALLAS OAK

CWS 211

Click: 5905167847770

Dryback: 5905167855690

Acoustic: 5905167858370



LINCOLN OAK

CWS 212

Click: 5905167847787

Dryback: 5905167855706

Acoustic: 5905167858387



DAYTON OAK
CWS 201



NORDLAND OAK
CWS 207

ARBITON WOODRIC



12 DESIGNS



20 YEARS
WARRANTY
RESIDENTIAL



THERMAL
RESISTANCE:
DRYBACK - 0,01 m²K/W
CLICK - 0,012 m²K/W

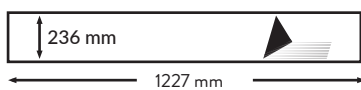
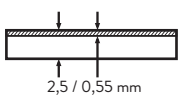
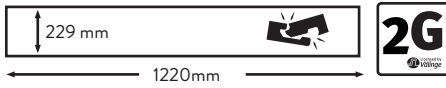
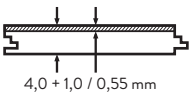
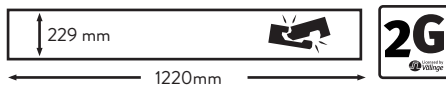
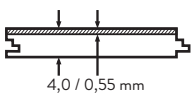

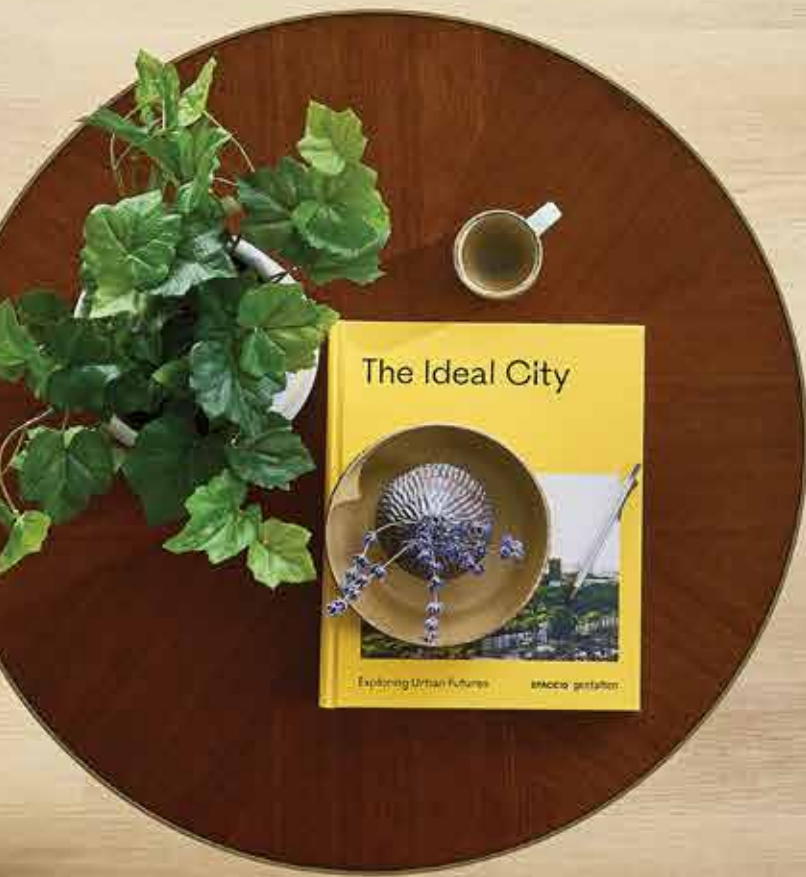

**CLICK
FLOORING**

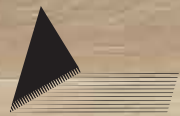

**DRYBACK
FLOORING**



**INTEGRATED
ACOUSTIC
LAYER**

**3 SYSTEMS
OF FLOOR
INSTALLATION**

WOODRIC



Our newest collection of vinyl click floors. This floor is made in Europe in new Arbiton's factory. Woodric will amaze even the most demanding people and provide them the best quality and 12 modern designs. With 0,5 mm wear layer and additional protective antiscratch layer you can be sure Woodric will withstand anything your household members will throw at it!



WHITECREEK OAK

CW 175

Click: 5905167847558

Dryback: 5905167855478

Acoustic: 5905167858158



HAYWORTH OAK

CW 176

Click: 5905167847565

Dryback: 5905167855485

Acoustic: 5905167858165



MEDICCI OAK

CW 177

Click: 5905167847572

Dryback: 5905167855492

Acoustic: 5905167858172



PETERSON OAK

CW 178

Click: 5905167847589

Dryback: 5905167855508

Acoustic: 5905167858189



ROCKFORD OAK

CW 179

Click: 5905167847596

Dryback: 5905167855515

Acoustic: 5905167858196



LAWRENCE OAK

CW 180

Click: 5905167847602

Dryback: 5905167855522

Acoustic: 5905167858202



STAMFORD OAK

CW 181

Click: 5905167847619

Dryback: 5905167855539

Acoustic: 5905167858219



HOLMAN OAK

CW 182

Click: 5905167847626

Dryback: 5905167855546

Acoustic: 5905167858226



ROSEVILLE OAK

CW 183

Click: 5905167847633

Dryback: 5905167855553

Acoustic: 5905167858233



WINDSOR OAK

CW 184

Click: 5905167847640

Dryback: 5905167855560

Acoustic: 5905167858240



TIMBERSLAND OAK

CW 185

Click: 5905167847657

Dryback: 5905167855577

Acoustic: 5905167858257



LAKWOOD OAK

CW 186

Click: 5905167847664

Dryback: 5905167855584

Acoustic: 5905167858264



WINDSOR OAK
CW 184

COMPREHENSIVE FLOORING SYSTEM



UNDERLAYS
SKIRTING BOARDS





UNDERLAYS



MULTIPROTEC VINYL CLICK

Special needs require special solutions. For areas with high level of traffic. Floors with click system require an underlay with high value of Compressive Strength. This is exactly what you can expect from our products. If the underfloor will be used do not worry you are covered – our products also perform well with underfloor heating thanks to the low value of thermal resistance. Additionally, Multiprotec products have a **Bfl-S1** fire class.



www.blauer-engel.de/uz156

SECURA VINYL CLICK

Products dedicated for vinyl floors with click system. Suitable for areas with high traffic level. High CS value improves the quality of the system and increases the durability of the floor. This product is very easy to install and align thanks to accordion form and cutting lines. High IS value - **(IS = 19dB)** for this XPS products allows for implementation in commercial areas where special parameters are required.



MULTIPROTEC VINYL CLICK



MATERIAL	PUM+PET
THICKNESS	1,4 mm
FORM	ROLL / 8,5 m ²
PC	CLASS PC2 (<1,2 mm)
CS	CLASS CS3 (400 kPa)
CC	CLASS CC3 (<70 kPa)
DL	CLASS DL3 (> 3 000 000 CYCLES)
RLB	CLASS RLB3 (≤1500 mm)
IS	<16 dB
RWS	58 sones
FLOOR HEATING	YES
THERMAL COMFORT	<0,008 m ² K/W
SD	>75 m
EAN	5905167776339

MULTIPROTEC VINYL CLICK ANTISLIP



MATERIAL	PUM+PET
THICKNESS	1,6 mm
FORM	ROLL / 8,5 m ²
PC	CLASS PC2 (<1,4 mm)
CS	CLASS CS3 (400 kPa)
CC	CLASS CC3 (<60 kPa)
DL	CLASS DL3 (> 3 000 000 CYCLES)
RLB	CLASS RLB3 (≤1500 mm)
IS	<16 dB
RWS	58 sones
FLOOR HEATING	YES
THERMAL COMFORT	<0,008 m ² K/W
SD	-
EAN	5905167721230

* REMOVE PROTECTIVE FOIL BEFORE INSTALL PANELS

MULTIPROTEC CLICK ACOUSTIC



MATERIAL	PUM+PET
THICKNESS	2,2 mm
FORM	ROLL / 7 m ²
PC	CLASS PC2 (<1,7 mm)
CS	CLASS CS3 (300 kPa)
CC	CLASS CC3 (<50 kPa)
DL	CLASS DL3 (> 3 000 000 CYCLES)
RLB	CLASS RLB2 (≤1100 mm)
IS	<18 dB
RWS	58 sones
FLOOR HEATING	YES
THERMAL COMFORT	<0,01 m ² K/W
SD	>75 m
EAN	5905167846063

SECURA VINYL CLICK



MATERIAL	M-XPS+PET
THICKNESS	1,5 mm
FORM	SMART / 6,25 m ²
PC	CLASS PC2 (<1,0 mm)
CS	CLASS CS3 (400 kPa)
CC	CLASS CC2 (<40 kPa)
DL	CLASS DL3 (>1 000 000 CYCLES)
RLB	CLASS RLB3 (≤1500 mm)
IS	up to 21 dB / 10 dB Δ _{in}
RWS	60 sones
FLOOR HEATING	YES
THERMAL COMFORT	<0,04 m ² K/W
SD	>150 m
EAN	5905167816943

TORE MONOCOLOR

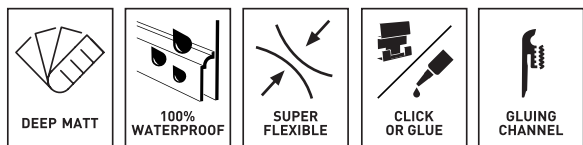

PROTECTIVE FOIL
Protective foil removable after renovation

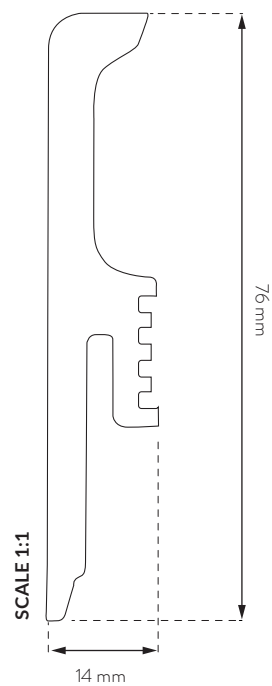

01 | White (RAL 9003)

TORE80 | 5905167845905
 | 22 m

05 | Black (RAL 9011)

TORE80 | 5905167845912
 | 22 m

STIQ XL

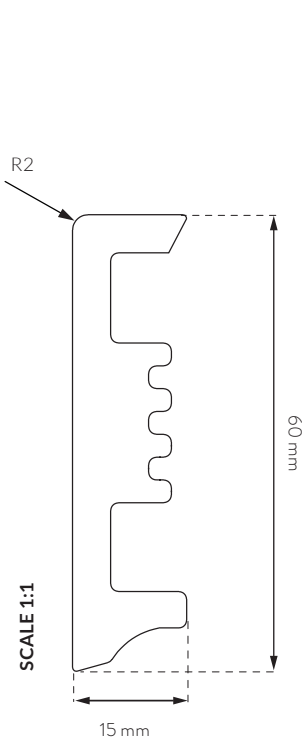
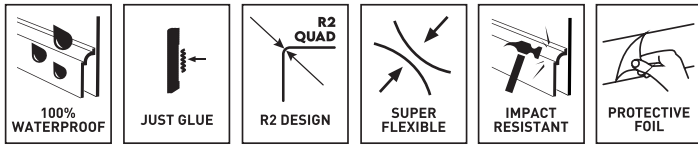

White
 STX610 | 5905167839874
 44 m

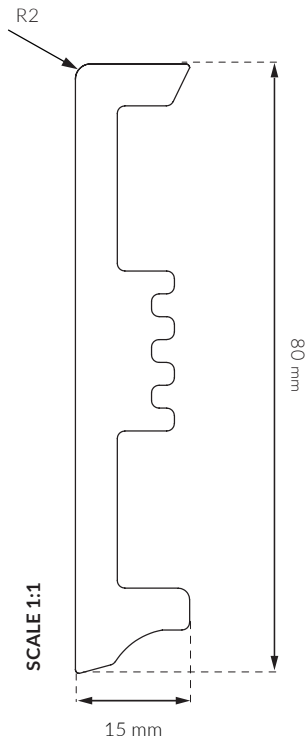

White
 STX810 | 5905167839881
 44 m

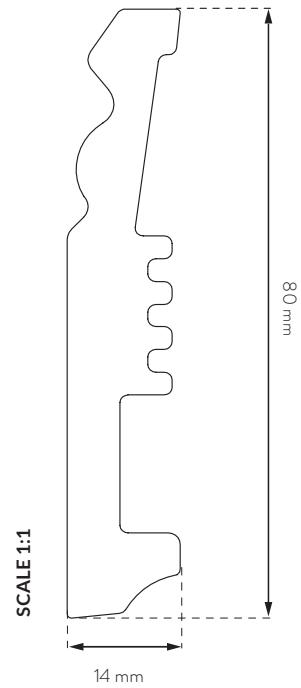

White
 STX820 | 5905167839898
 44 m



SUPERIORE

SU CASS205	BEATRICE OAK	5905167856505
SU CASS225	SEGOVIA OAK	5905167856512
SU CASS208	BURBON OAK	5905167856529
SU CASS210	ASTURIA OAK	5905167856536
SU CASS202	GREYLAND OAK	5905167856543
SU CASS233	CHARLOTTE OAK	5905167856550
SU CASS234	CHEVALIER OAK	5905167856567
SU CASS235	BALMORAL OAK	5905167856574

AMARON HERRINGBONE

CA158	HARLOW OAK	5905167826676
CA159	WEMBLEY OAK	5905167826683
CA 153	YANKEE OAK	5905167839348
CA 147	GEORGETOWN OAK	5905167839355
CA 167	PRESTON OAK	5905167839362
CA 176	HAYWORTH OAK	5905167839492
CA 177	MEDICCI OAK	5905167839508
CA 178	STAMFORD OAK	5905167839515
CA 187	DEARWOOD OAK	5905167839522
CA 184	WINDSOR OAK	5905167839539
CAS 223	MENOR OAK	5905167857090
CAS 226	EMPIRE OAK	5905167857106
CAS 208	BURBON OAK	5905167857113
CAS 236	DEVENTER OAK	5905167857120

AMARON WOOD

CA 102	ALASKAN OAK	5905167856369
CA 153	YANKEE OAK	5905167856376
CA 154	SIERRA OAK	5905167856383
CA 147	GEORGETOWN OAK	5905167856390
CAS 220	TAMPA OAK	5905167856406
CAS 221	MATTARI OAK	5905167856413
CAS 222	JOHANNES OAK	5905167856420
CAS 223	MENOR OAK	5905167856437
CAS 224	CORNEL OAK	5905167856444
CAS 225	MONTANA OAK	5905167856451
CAS 226	EMPIRE OAK	5905167856468
CAS 227	VIRGIN OAK	5905167856475
CAS 228	PRINCETON OAK	5905167856482
CAS 229	ROCHESTER OAK	5905167856499

WOODRIC

CW 175	WHITECREEK OAK	5905167847558
CW 176	HAYWORTH OAK	5905167847565
CW 177	MEDICCI OAK	5905167847572
CW 178	PETERSON OAK	5905167847589
CW 179	ROCKFORD OAK	5905167847596
CW 180	LAWRENCE OAK	5905167847602
CW 181	STAMFORD OAK	5905167847619
CW 182	HOLMAN OAK	5905167847626
CW 183	ROSEVILLE OAK	5905167847633
CW 184	WINDSOR OAK	5905167847640
CW 185	TIMBERSLAND OAK	5905167847657
CW 186	LAKWOOD OAK	5905167847664

WOODRIC EIR

CWS 201	DAYTON OAK	5905167847671
CWS 202	BALTIMORE OAK	5905167847688
CWS 203	BRANDON OAK	5905167847695
CWS 204	ELDBORG OAK	5905167847701
CWS 205	HIGHLANDS OAK	5905167847718
CWS 206	LAVANT OAK	5905167847725
CWS 207	NORDLAND OAK	5905167847732
CWS 208	GARLAND OAK	5905167847749
CWS 209	SALERNO OAK	5905167847756
CWS 210	CAVAILLON OAK	5905167847763
CWS 211	DALLAS OAK	5905167847770
CWS 212	LINCOLN OAK	5905167847787

WOODRIC EIR ACOUSTIC

CWA175	WHITECREEK OAK	5905167858158
CWA176	HAYWORTH OAK	5905167858165
CWA177	MEDICCI OAK	5905167858172
CWA178	PETERSON OAK	5905167858189
CWA179	ROCKFORD OAK	5905167858196
CWA180	LAWRENCE OAK	5905167858202
CWA181	STAMFORD OAK	5905167858219
CWA182	HOLMAN OAK	5905167858226
CWA183	ROSEVILLE OAK	5905167858233
CWA184	WINDSOR OAK	5905167858240
CWA185	TIMBERSLAND OAK	5905167858257
CWA186	LAKWOOD OAK	5905167858264

WOODRIC ACOUSTIC

CWSA201	DAYTON OAK	5905167858271
CWSA202	BALTIMORE OAK	5905167858288
CWSA203	BRANDON OAK	5905167858295
CWSA204	ELDBORG OAK	5905167858301
CWSA205	HIGHLANDS OAK	5905167858318
CWSA206	LAVANT OAK	5905167858325
CWSA207	NORDLAND OAK	5905167858332
CWSA208	GARLAND OAK	5905167858349
CWSA209	SALERNO OAK	5905167858356
CWSA210	CAVAILLON OAK	5905167858363
CWSA211	DALLAS OAK	5905167858370
CWSA212	LINCOLN OAK	5905167858387

DRYBACK FLOORING



AMARON HERRINGBONE

CAA 158	HARLOW OAK	5905167857557
CAA 159	WEMBLEY OAK	5905167857564
CAA 153	YANKEE OAK	5905167857571
CAA 147	GEORGETOWN OAK	5905167857588
CAA 167	PRESTON OAK	5905167857595
CAA 176	HAYWORTH OAK	5905167857601
CAA 177	MEDICCI OAK	5905167857618
CAA 181	STAMFORD OAK	5905167857625
CAA 187	DEARWOOD OAK	5905167857632
CAA 184	WINDSOR OAK	5905167857649
CASA 223	MENOR OAK	5905167857656
CASA 226	EMPIRE OAK	5905167857663
CASA 208B	BURBON OAK	5905167857670
CASA 236	DEVENTER OAK	5905167857687

AMARON WOOD

DA 102	ALASKAN OAK	5905167857694
DA 153	YANKEE OAK	5905167857700
DA 154	SIERRA OAK	5905167857717
DA 147	GEORGETOWN OAK	5905167857724
DAS 220	TAMPA OAK	5905167857731
DAS 221	MATTARI OAK	5905167857748
DAS 222	JOHANNES OAK	5905167857755
DAS 223	MENOR OAK	5905167857762
DAS 224	CORNEL OAK	5905167857779
DAS 225	MONTANA OAK	5905167857786
DAS 226	EMPIRE OAK	5905167857793
DAS 227	VIRGIN OAK	5905167857809
DAS 228	PRINCETON OAK	5905167857816
DAS 229	ROCHESTER OAK	5905167857823

WOODRIC

DW 175	WHITECREEK OAK	5905167855478
DW 176	HAYWORTH OAK	5905167855485
DW 177	MEDICCI OAK	5905167855492
DW 178	PETERSON OAK	5905167855508
DW 179	ROCKFORD OAK	5905167855515
DW 180	LAWRENCE OAK	5905167855522
DW 181	STAMFORD OAK	5905167855539
DW 182	HOLMAN OAK	5905167855546
DW 183	ROSEVILLE OAK	5905167855553
DW 184	WINDSOR OAK	5905167855560
DW 185	TIMBERSLAND OAK	5905167855577
DW 186	LAKEWOOD OAK	5905167855584

WOODRIC EIR

DWS 201	DAYTON OAK	5905167855591
DWS 202	BALTIMORE OAK	5905167855607
DWS 203	BRANDON OAK	5905167855614
DWS 204	ELDBORG OAK	5905167855621
DWS 205	HIGHLANDS OAK	5905167855638
DWS 206	LAVANT OAK	5905167855645
DWS 207	NORDLAND OAK	5905167855652
DWS 208	GARLAND OAK	5905167855669
DWS 209	SALERNO OAK	5905167855676
DWS 210	CAVAILLON OAK	5905167855683
DWS 211	DALLAS OAK	5905167855690
DWS 212	LINCOLN OAK	5905167855706



www.arbiton.com

The catalogue is a free of charge presentation of products of Decora S.A. and acc. to valid law it is not a commercial offer. Colors and textures of the products in pictures may differ from real ones because of limited printing technologies. Decora S.A. reserves its right to alter availability of the products on some markets and at some distributors. The products included in the catalogues do not pose a complete offer of Decora S.A.

DECORA GROUP

Decora S.A., ul. Prądyńskiego 24a
63-000 Środa Wlkp., Polska
tel.: +48 61 28 64 200
fax: +48 61 28 54 975
e-mail: sales@decora.pl
www.arbiton.com

GERMANY

ewifoam E. Wicklein GmbH
Stockumer Str. 28
58453 Witten
Tel.: +49 (0) 9261 50 490-0
Fax.: +49 (0) 9261 50 490-50
info@ewifoam.de
www.ewifoam.de

v04.2023